

Sensor/Actuator cable - SAC-HZ-5P-2,0-542/FS SCO BK - 1409637

Please be informed that the data shown in this PDF Document is generated from our Online Catalog. Please find the complete data in the user's documentation. Our General Terms of Use for Downloads are valid (<http://phoenixcontact.com/download>)



Sensor/Actuator cable, 5-position, PVC, yellow, free cable end, on Socket straight M12 SPEEDCON, A-coded, Cable length: 2 m



Key Commercial Data

Packing unit	1 STK
Minimum order quantity	10 STK
GTIN	 4 055626 018805
GTIN	4055626018805

Technical data

Dimensions

Length of cable	2 m
-----------------	-----

Ambient conditions

Ambient temperature (operation)	-25 °C ... 90 °C (Plug / socket)
Degree of protection	IP65
	IP67
	IP68

General

Note	These cable assemblies are UL/cUL listed for use in Class I, Division 2 (CID2) hazardous locations.
Number of positions	5
Coding	A - standard
Standards/regulations	M12 connector IEC 61076-2-101
Status display	No
Protective circuit/component	Unwired
Overvoltage category	II
Degree of pollution	3

Sensor/Actuator cable - SAC-HZ-5P-2,0-542/FS SCO BK - 1409637

Technical data

General

Torque	0.4 Nm (M12 connector)
--------	------------------------

Material

Flammability rating according to UL 94	HB
Contact material	CuSn
Contact surface material	Ni/Au
Contact carrier material	TPU GF
Material of grip body	TPU, hardly inflammable, self-extinguishing
Material, knurls	Zinc die-cast, nickel-plated

Standards and Regulations

Standard designation	M12 connector
Standards/regulations	IEC 61076-2-101
Flammability rating according to UL 94	HB
UL, USA/Canada	Class I, Div. 2, Groups A, B, C, D

Cable

Cable type	PVC yellow 105 °C
Cable type (abbreviation)	542
UL AWM style	2517 (105 °C / 300 V)
AWG signal line	22
Core diameter including insulation	1.27 mm ±0.03 mm
Wire colors	Brown, blue, black, white, gray
Overall twist	5 wires around filler to the core
External sheath, color	yellow
External cable diameter D	5.4 mm ±0.2 mm
Minimum bending radius, flexible installation	8 x D
Cable weight	43 kg/km
Outer sheath, material	PVC
Material, filler	PP
Material conductor insulation	PVC
Conductor material	Tin-plated Cu litz wires
Insulation resistance	≥ (550 M Ohms/m @ 500V)
Conductor resistance	max. 50.5 Ω/km (20° C)
Nominal voltage, cable	300 V
Special properties	UL standards PLTC and ITC
Flame resistance	FT4
Other resistance	UV resistant
Ambient temperature (operation)	-30 °C ... 105 °C (cable, fixed installation)

Drawings

Sensor/Actuator cable - SAC-HZ-5P-2,0-542/FS SCO BK - 1409637

Schematic diagram

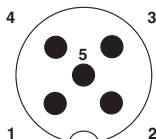

Pin assignment M12 male connector, 5-pos., A-coded, male side

Schematic diagram

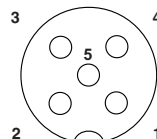

Pin assignment M12 socket, 5-pos., B-coded, female side

Cable cross section

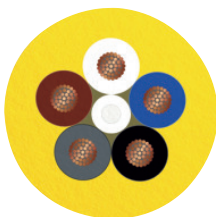

PVC yellow 105 °C [542]

Dimensional drawing

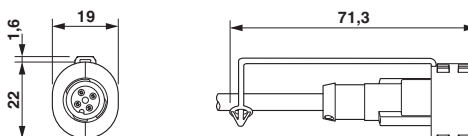

EXCLIP mounted plug

Dimensional drawing

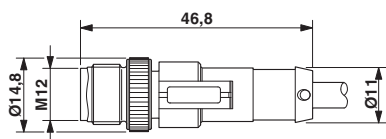

Plug, M12 x 1, straight, shielded

Dimensional drawing

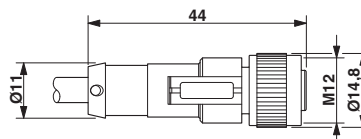

M12 x 1 socket, straight

Dimensional drawing

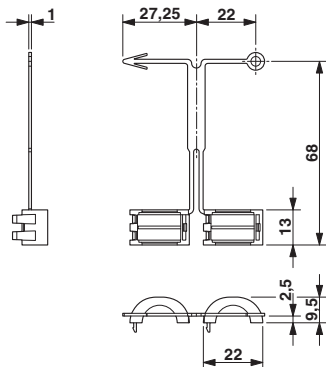

EXCLIP socket

Circuit diagram



Contact assignment of the M12 plug and the M12 socket

Phoenix Contact 2017 © - all rights reserved
<http://www.phoenixcontact.com>

PHOENIX CONTACT GmbH & Co. KG
Flachmarktstr. 8
32825 Blomberg
Germany
Tel. +49 5235 300
Fax +49 5235 3 41200
<http://www.phoenixcontact.com>