



ITT

Interconnect Solutions  
Cannon, VEAM, BIW

Providing **100% reliable**  
electrical connections for over **65 years**  
on commercial and **military aircrafts**  
and over a **150 billion** miles flown



*Engineered for life*

BKAD/E/F/C/X

- Low insertion force contacts.
- Both environmental and non- environmental versions.
- Polarizing posts that are removable from the mating face.
- Field replaceable inserts for size 22 and power contacts.
- Up to 800 size 22 contacts in one connector.
- Crimp, coax, power, printed circuit and wire wrappable post style contacts.
- Uses standard DPX crimp, insertion/extraction tooling.
- Waveguide connections available.



**BKAC**

Rear Release/Rear Removable  
Size 12, 16, 20, 22 Crimp Contacts

BKAC is a combination of BKAD (no environmental O-ring) and inserts are not potted into shell and BKAE in which dielectric in inserts have a wire seal in the grommet on the rear surface.

**BKAD/E**

Rear Release/Rear Removable  
Size 12, 16, 20, 22 Crimp Contacts

BKAD/E connectors represent the standard for new avionic systems developed to support the air transportation market. Several important design concerns have been addressed and solved in this new series. High mating forces of pluggable modules in a rack have been reduced by approximately two-thirds.

The low insertion force contacts are also interchangeable with the contacts used in the DPX series and permit retrofit of existing equipment.

**BKAF/X**

Front Release/Front Removable  
Size 22 Solder Tail and Wrap Post Contacts

This new connector is totally intermateable and intermountable with ARINC 600 connectors now in the field.

The BKAF permits the user to easily replace a contact in case of problems, rather than disassemble the entire connector--it is available with size 22 contacts in wrap post or solder-tail versions. The system maintains the advantages of low insertion force technology incorporated in all ARINC 600 connectors. BKAX contacts are front release and front removable.

Pos-Aline Connector Construction Feature

In the ARINC 600 connector series, Size 22 contacts are the only size that utilize this design feature. The hooded socket extends from its insulator while the pin contacts are shrouded by its front insulator. All other contacts used in this series employ standard contact design.

The result is that the complement of contacts for the plug connectors will consist of pin contacts for size 22 and socket contacts for all others. The receptacle contacts will be just the reverse, socket contact for size 22 and pin contacts for the balance.

Material Specifications

		BKAD	BKAE/C	BKAF/X	Specifications
Shell & Waveguide	Material	Aluminum alloy	Aluminum alloy	Aluminum alloy	QQ A-591/A380
	Finish	Alodine 1200	Alodine 1200	Alodine 1200	MIL-C-5541
Insulator	Material	Thermoset	Thermoset	Thermoset	N/A
	Material	Copper alloy	Copper alloy	Copper alloy	QQ-C-533
Contacts	Finish	Gold over Nickel	Gold over Nickel	Gold over Nickel	MIL-G-45204
	Termination	Crimp	Crimp	P.C./Wrap Post	N/A
Grommets/Seals	Material	N/A	Silicone-based Elastomer	N/A	N/A
O-Ring	Material	N/A	Silicone-based Elastomer	N/A	N/A

How to Order

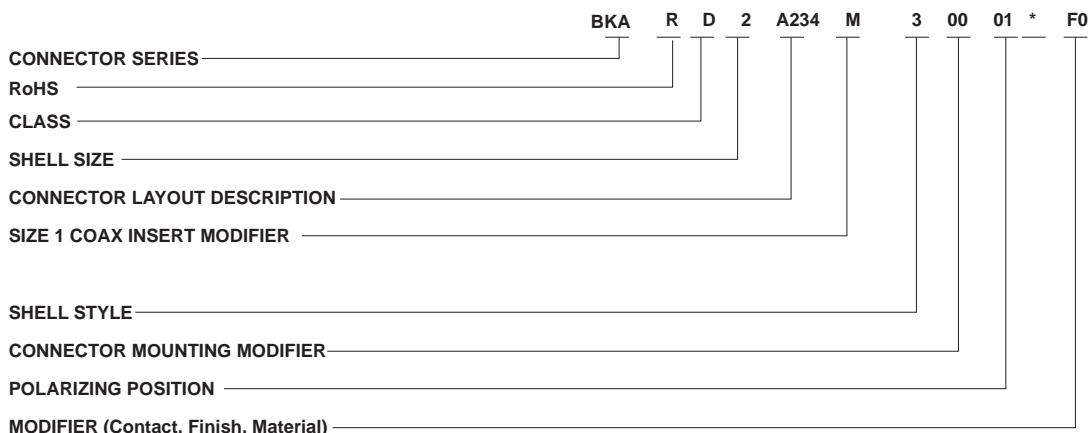

\* = For Polarizing Position greater than 99, add third digit.

**CONNECTOR SERIES**

BKA (Per ARINC 600)

**RoHS version**

R - RoHS compatible

**CLASS**

- D - Non-environmental (rear release, crimp contacts)
- E - Environmental (rear release, crimp contacts)
- F - Non-environmental (front release, solder and wrap post #22 contact, all others are rear release)
- C - Same as E, except uses BKAD shells and Less 0 rings on plug side.
- T - Non-environmental connector using filtered contacts. See ITT Filter Connector catalog for further details. (Reference only)
- X - All contacts are front release

**SHELL SIZE**

- 1 - Max. contact capacity - 125
- 2 - Max. contact capacity - 400
- 3 - Max. contact capacity - 800

ARINC 600 ORIGINAL MATING FORCES

- 27 lbs \*
- 60 lbs \*
- 105 lbs \*

**CONNECTOR LAYOUT DESCRIPTION**

(See page 8)

**SIZE 1 COAX INSERT MODIFIER**

- M - Connector contains modified 71W1 or 2W2 insert (four Mounting screw hole locations and coaxial contact used in this insert are interchangeable between other manufacturers)

**SHELL STYLE**

- 3 - Plug (rack side)
- 4 - Receptacle (box side)

**CONNECTOR MOUNTING MODIFIER**

- 00 - Standard design, .148 dia. holes
- 01 - With #6-32 ESNA (#12 NCFMA2-62) clinch nuts (see chart)

Connector Size	Number of Clinch Nuts	
	Plug	Receptacle
1	4	4
2	4	6
3	8	10

- 02 - Size 1 receptacle only - less 3 printed circuit board mounting lugs
- 03 - With #4-40 ESNA (#22 NCFMA2-40) clinch nuts (see chart)
- 08 - Size 2 and 3 plug and receptacle only - with #4-40 ESNA (#22 NCFMA2-40) clinch nuts (all mounting holes)
- 09 - Size 2 and 3 plug and receptacle only - with #6-32 ESNA (#12 NCFMA2-62) clinch nuts (all mounting holes)
- 22 - Same as - 00 mounting modification except with nickel finished shells .0008 - .0012 thick with EMI grounding spring for plug shells and supplied with non-environmental inserts.
- 23 - With floating eyelets (.048 min. radial float) 4 corner holes per connector.

Consult Customer Service if other modifications are required

NOTE: A dash must be inserted whenever code does not apply.

ROHS alodine replacement to be trivalent chromate coating.

ROHS electroless nickel replacement to be electroless nickel per FS 4971 Code R (.0012-.0008) thick.

\*ARINC is in the process of re-evaluating the maximum mating forces based new contact arrangements using increased amounts of Coax, Twinax, Triax, Quadrax and Fiber Optic contacts.

How to Order (continued)

**CONNECTOR LAYOUT DESCRIPTION** Note: All layouts with "OPEN" insert cavity are not supplied with an insulator. If a Blank insert is required please consult factory.  
Three Digit Number Contained within the Shell Layout Indicates Total Number of Contacts Available (including Waveguide)

Connector Layout	Shell Size	Shell Cavity Identification						Ref. ARINC Characteristic	Connector Layout	Shell Size	Shell Cavity Identification						Ref. ARINC Characteristic
		A	B	C	D	E	F				A	B	C	D	E	F	
-005	1	OPEN	OPEN	5W2				-173	2	150	10T10	13W2					
-060	1	OPEN	60	OPEN				234	2	150	71W1	13W2					709
A060	1	60	OPEN	OPEN				A234	2	71W1	150	13W2					727
-065	1	OPEN	60	5W2				-246	2	120T2	120T2	6T6					
A065	1	60	Open	5W2				-248	2	121	121	6T6					
-120	1	60	60	OPEN				250	2	OPEN	150	100					
-125	1	60	60	5W2			•	250A	2	150	BLANK	100					
-013	2	OPEN	OPEN	13W2				-251	2	Waveguide	150	100					
-017	2	2W2	2W2	13W2				-300	2	150	150	OPEN					
-071	2	OPEN	71W1	OPEN				-306	2	150	150	6T6					
A071	2	71W1	OPEN	OPEN				-313	2	150	150	13W2					• • •
-085	2	Waveguide	71W1	13W2				-370	2	150	120T2	100					
A085	2	71W1	Waveguide	13W2				-400	2	150	150	100					
86M	2	2W2	71W1A	13W2				-021	3	4W4	4W4	13W2	BLANK	OPEN	OPEN		
-093	2	4W4	4W4	85				-026	3	OPEN	OPEN	13W2	OPEN	OPEN	13W2		
-100	2	OPEN	OPEN	100				-113	3	OPEN	OPEN	100	OPEN	OPEN	13W2		
-137	2	121	10T10	6T6				-A113	3	OPEN	OPEN	13W2	OPEN	OPEN	100		
-143	2	120T2	10T10	13W2				-114	3	4W4	4W4	13W2	4W4	4W4	85		
-142	2	71W1	71W1	OPEN				-284	3	71W1	71W1	OPEN	71W1	71W1	OPEN		
-155	2	71W1	71W1	13W2			• •	-310	3	71W1	71W1	13W2	71W1	71W1	13W2		
155M	2	71W1A	71W1A	13W2				-330M	3	2W1	2W2	13W2	150	150	13W2		
V155M	2	71W1B	71W1A	13W2				-A330M	3	150	150	13W2	2W2	2W2	13W2		
158M	2	2W2	71W1A	85				-496	3	121	121	6T6	121	121	6T6		
-A158M	2	2W2	71W1B	85				-600	3	150	150	OPEN	150	150	OPEN		
-163	2	OPEN	150	13W2				-626	3	150	150	13W2	150	150	13W2		• • • •
A163	2	150	OPEN	13W2				-713	3	150	150	100	150	150	13W2		
-164	2	150	Waveguide	13W2				A713	3	150	150	13W2	150	150	100		
A164	2	Waveguide	150	13W2			708	-734	3	150	150	100	150	150	3W		
165M	2	150	2W2	13W2				-764	3	150	150	64	150	150	100		
-A165M	2	2W2	150	13W2				-800	3	150	150	100	150	150	100		
-167	2	4W4	150	13W2				-269M	3	2W2	2W2	13W2	2W2	150	100		732
173M	2	2W2	71W1B	100				271C	3	4W4	4W4	13W2	BLANK	150	100		
								271M	3	2W2	2W2	13W2	4W4	150	100		
								-326	3	OPEN	150	13W2	OPEN	150	13W2		

**NOTE. ANY OTHER COMBINATION OF INSERTS WITHIN A SPECIFIC SHELL IS AVAILABLE UPON REQUEST**

- Layout included in the following ARINC configurations 702, 710, 711, 712, 714, 715, 716, 723.
- • Layout included in the following ARINC configurations 707, 718 & 730.
- • • Layout included in the following ARINC configurations 701, 702, 703, 704, 705, 706, 724, 725.
- • • • Layout included in the following ARINC configurations 701, 717, 726, 729.

For additional layouts, consult factory

**POLARIZING POSITION**

01 thru 216 (per ARINC 600) 00 for polarization indicates that polarizing hardware is not supplied (ie, BKADZ-313-30000)  
Blank or no position indicated means - Polarizing posts or keys not installed but supplied with connector (ie, BKADZ-313-300)

**MODIFIER (Contact, Finish, Material)**

- |   |  |   |
|---|--|---|
| Blank - Rear release, crimp, signal and power contacts supplied with connector (when applicable)  | SC - Front release .025(0.63) D. x .375 (9.53) solder post and crimp, rear release power contacts (when applicable) supplied with connector          | WC - Front release .025(0.63) Sq. x 500 (12.7) (3 wraps) wrap post and crimp, rear release power contacts (when applicable) supplied with connector   |
| FO - Contacts not supplied with connector (FO not stamped on connector)   | SD - Front release .025(0.63) D. x .500 (12.7) solder post and crimp, rear release power contacts (when applicable) supplied with connector          | WD - Front release .025 (0.64) Sq. x 641 (16.28) (3 wraps) wrap post and crimp, rear release power contacts (when applicable) supplied with connector |
| FOO - Less contacts and waveguide (FOO not stamped on connector)  | WA - Front release .025(0.63) Sq. x .250 (6.35) (1 wrap) wrap post and crimp, rear release power contacts (when applicable) supplied with connector  |   |
| SA - Front release .025(0.63) D. x .150 (3.81) solder post and crimp, rear release power contacts (when applicable) supplied with connector | WB - Front release .025(0.63) Sq. x .375 (9.53) (2 wraps) wrap post and crimp, rear release power contacts (when applicable) supplied with connector |   |
| SB - Front release .025(0.63) D. x .250 (6.35) solder post and crimp, rear release power contacts (when applicable) supplied with connector |  |   |

NOTE: COAXIAL CONTACTS TO BE ORDERED SEPARATELY



Rack and Panel

Shell Dimensions – Size 1

Plug

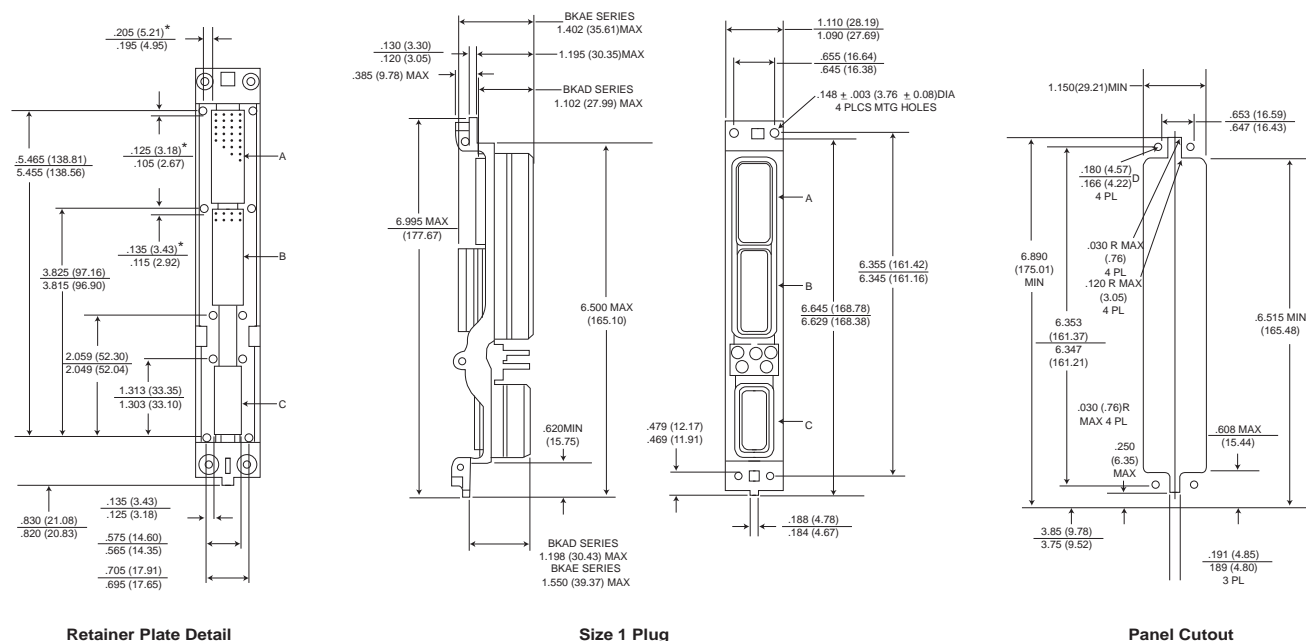

\* This dimension indicates distance from centerline of retaining screw to the centerline of first contact cavity.

For further information, refer to ARINC 600 specification or consult factory.



Rack and Panel

Receptacle

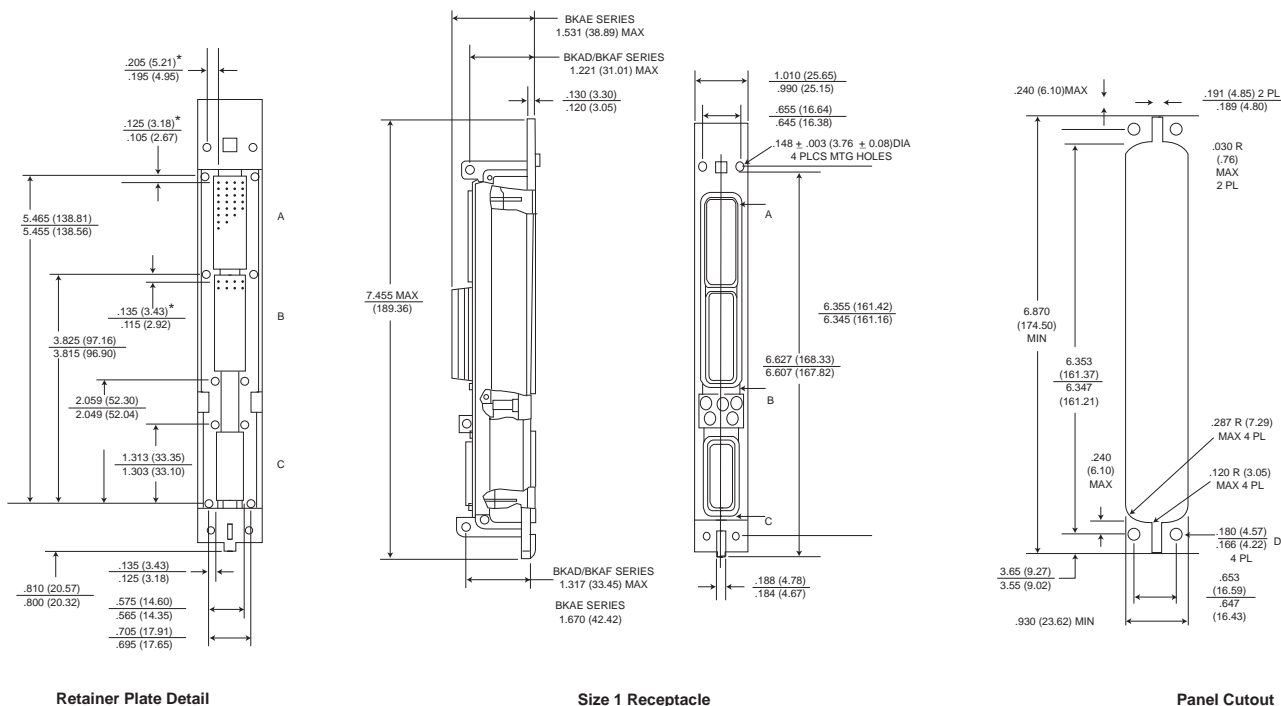

\*This dimension indicates distance from centerline of retaining screw to the centerline of first contact cavity.

For further information, refer to ARINC 600 specification or consult factory.

Dimensions shown in inches (mm)  
Specifications and dimensions subject to change



Shell Dimensions – Size 2

Plug

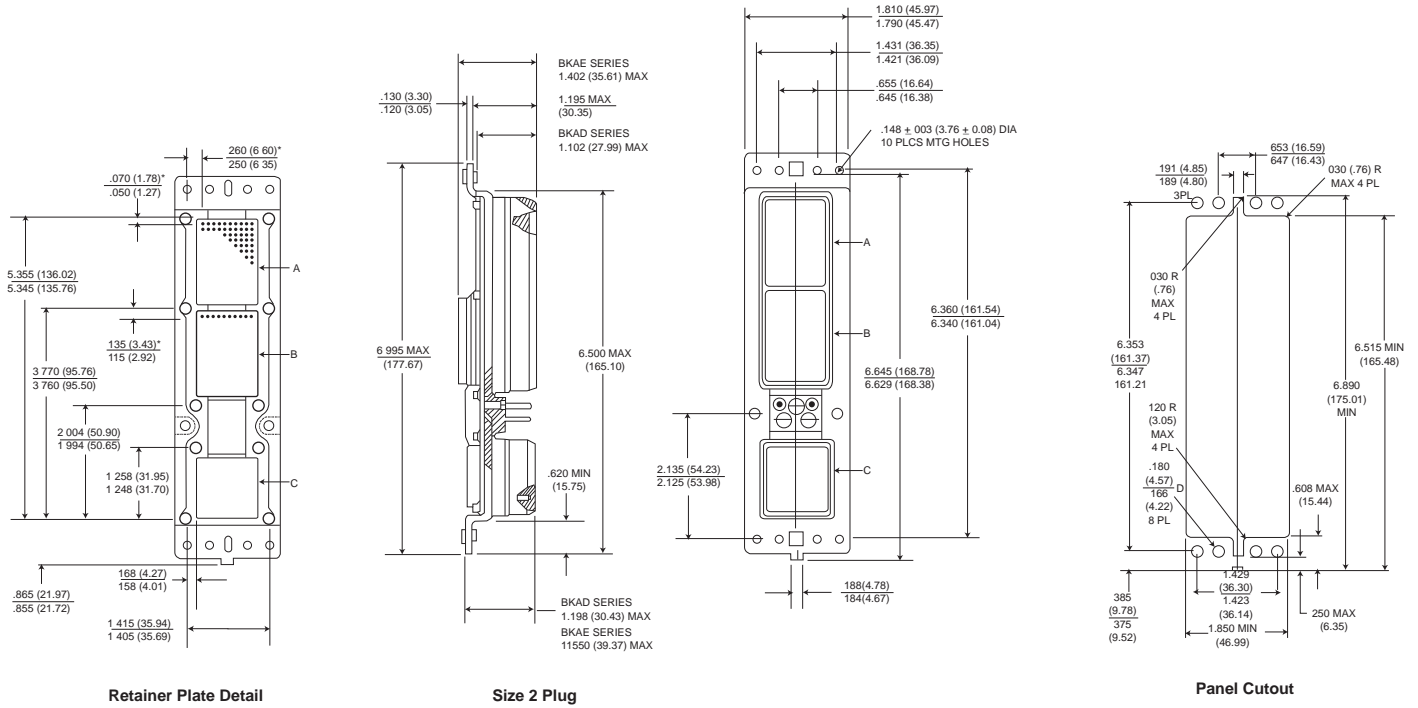

\* This dimension indicates distance from centerline of retaining screw to the centerline of first contact cavity.

For further information, refer to ARINC 600 specification or consult factory.

Receptacle

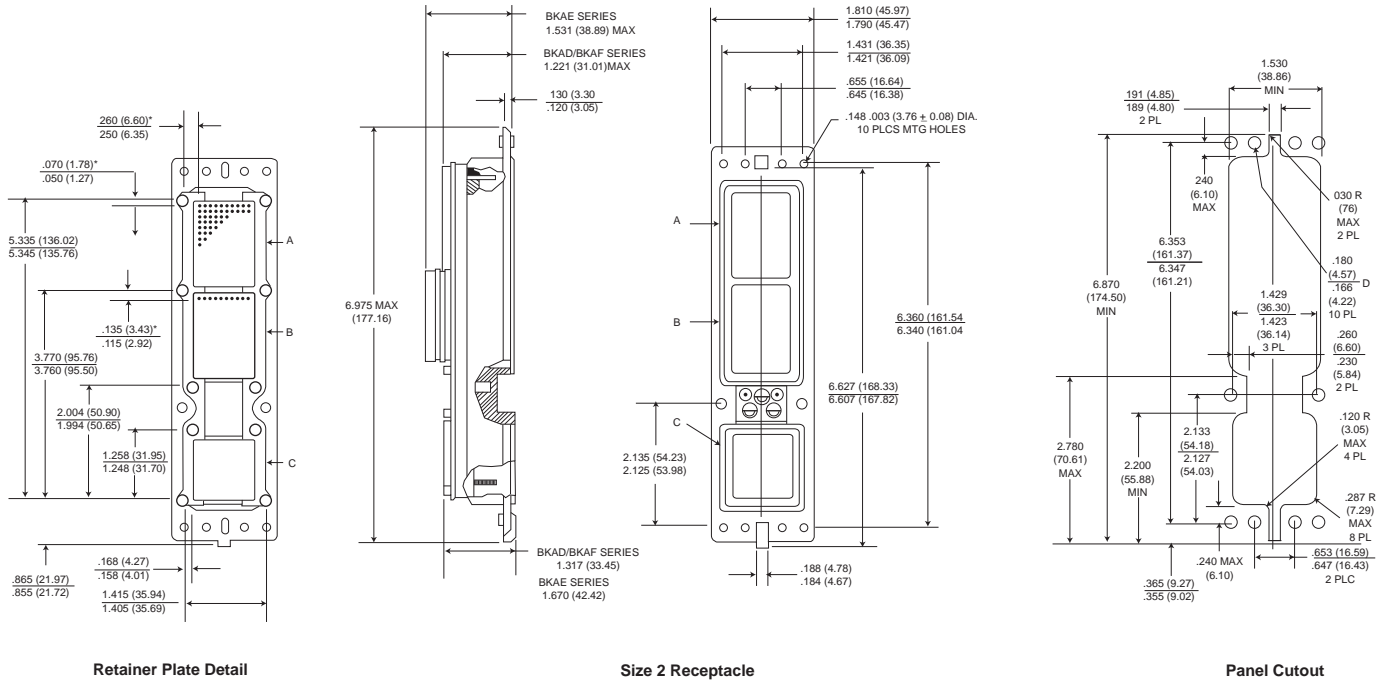

\*This dimension indicates distance from centerline of retaining screw to the centerline of first contact cavity.

For further information, refer to ARINC 600 specification or consult factory.

Shell Dimensions – Size 3

Plug

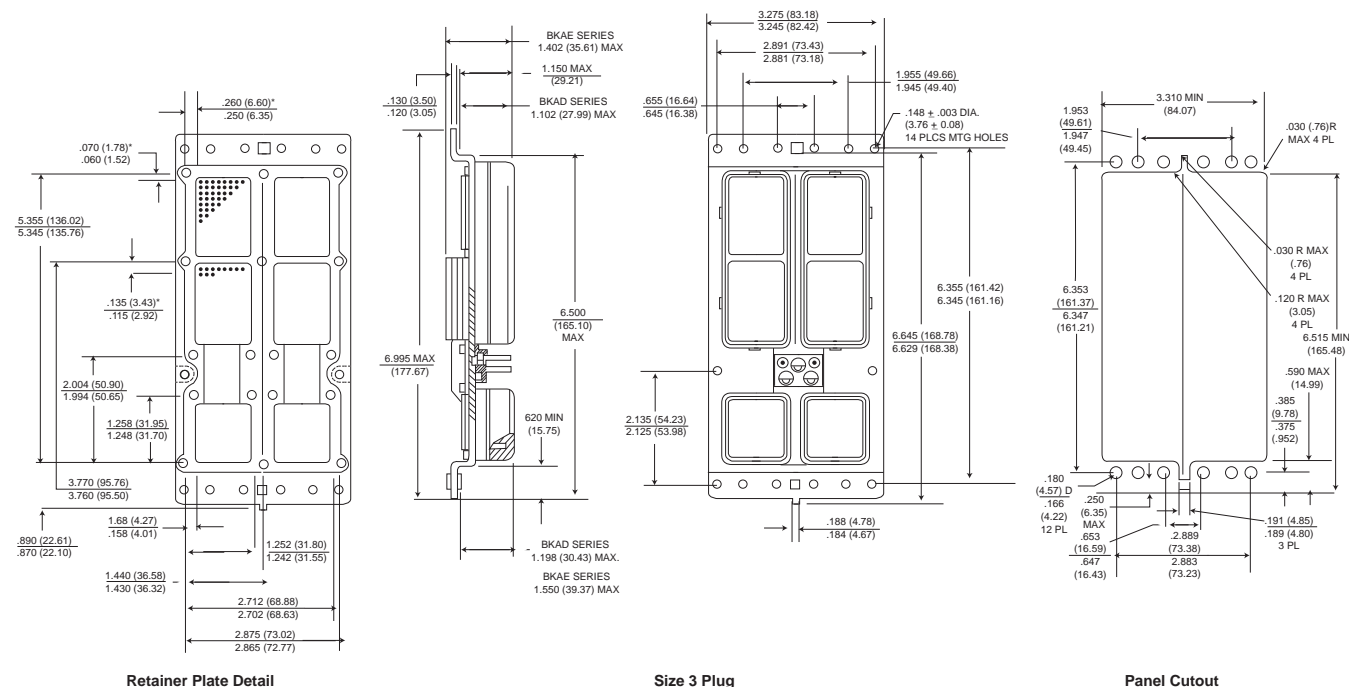

\* This dimension indicates distance form centerline of retaining screw to the centerline of first contact cavity.

For further information, refer to ARINC 600 specification or consult factory.

Receptacle

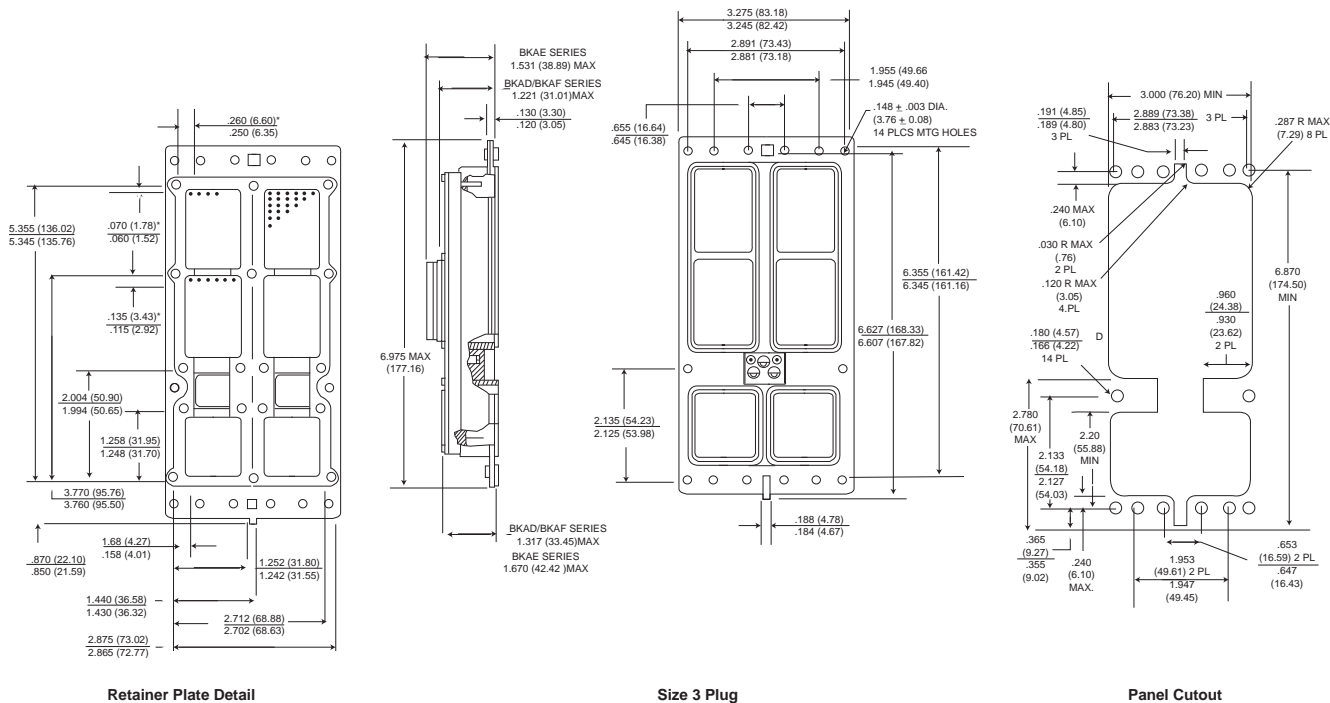

\* This dimension indicates distance form centerline of retaining screw to the centerline of first contact cavity.

For further information, refer to ARINC 600 specification or consult factory.

Contact Arrangements – Shell Size 1

BKAD/BKAE (Plug Rear face shown)

BKAF - Available Receptacle Shell Only  
(Front Release)

Shell Cavity  
A or B

Shell Cavity  
C

Shell Cavity  
A or B

Shell Cavity  
C

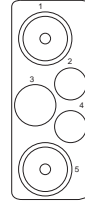
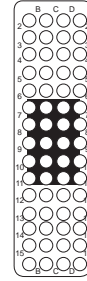
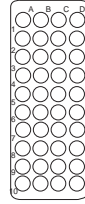
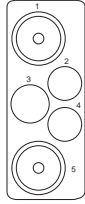
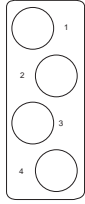
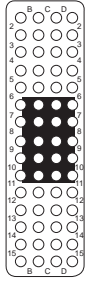
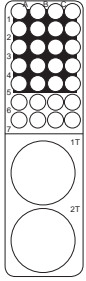

30T2  
28 #22  
2 #8 TWINAX/COAX  
(#8 Grounded to Shell)

60  
60 #22

4  
4 #12

5W2  
1 #12  
2 #16  
2 #5 COAX

40  
40 #22

60  
60 #22

5W2  
1 #12  
2 #16  
2 #5 COAX

REAR SURFACE WHITE ON BLUE TO INDICATE REAR RELEASE REAR REMOVAL CONTACTS

ENGAGING END SURFACE WHITE ON RED TO INDICATE FRONT RELEASE FRONT REMOVAL CONTACTS

(For Contact Cavity Location and Contact Cavity Identification refer to ARINC 600 or consult factory)

Contact Arrangements – Shell Sizes 2 and 3

BKAD/BKAE (Plug Rear face shown)

Shell Cavity  
C or F

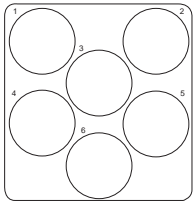

6  
6 #8

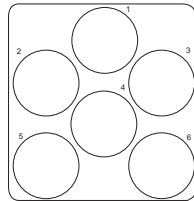

6T6  
6 #8 TRIAX  
(Metallic Insert)

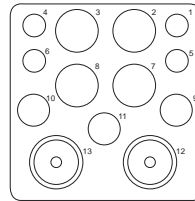

13W2  
4 #20, 4 #12, 3 #16  
2 #5 COAX

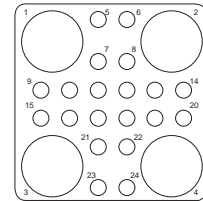

24T4\*\*  
20 #20, 4 #8 TRIAX

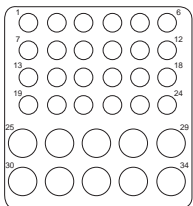

3  
24 #20 HD, 10 #16

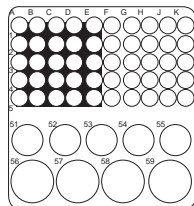

59  
50 #22, 5 #16, 4 #12

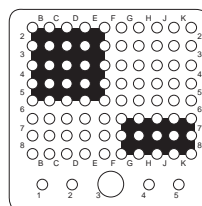

85  
80 #22, 4 #20, 1 #16

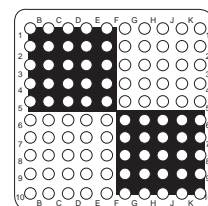

100  
100 #22

NOTE: In layouts using #22 contacts mixed with any other contact size (20HD, 16, 12), the size #22 contact type (pin or socket) determines the insulator as a pin insert or a socket insert.

REAR SURFACE WHITE ON BLUE TO INDICATE REAR RELEASE, REAR REMOVAL CONTACTS FOR INSERTS CONTAINING STANDARD SIGNAL & POWER CONTACTS

(For Contact Cavity Location and Contact Cavity Identification refer to ARINC 600 or consult factory)



Contact Arrangements – Shell Sizes 2 and 3

BKAD/BKAE (Plug Rear face shown)  
Shell Cavity  
A,B,D,E

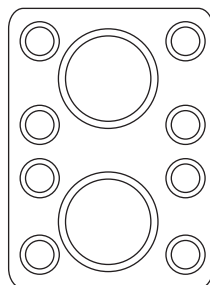

2W2  
2 #1 COAX

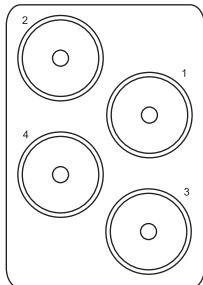

4W4  
4 Modified  
#1 COAX  
(Metallic Insert)

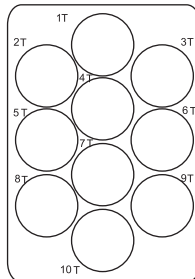

10T10  
10 #8 TRIAX/COAX  
(#8 Grounded to Shell)  
(Metallic Insert)

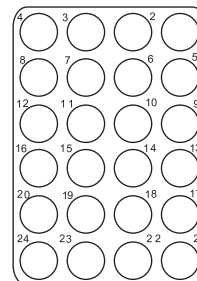

24\*\*  
24 #12

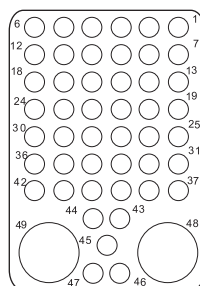

49T2\*\*  
47 #20  
2 #8 TRIAX

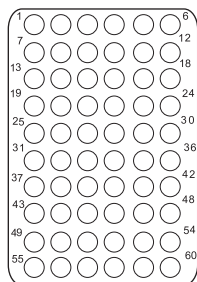

60\*\*  
60 #20

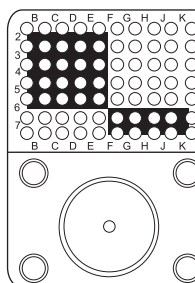

71W1  
70 #22  
1 #1 COAX

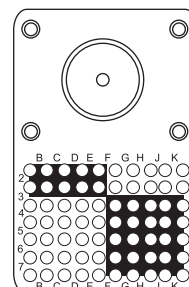

71W1B  
70 #22  
1 #1 COAX

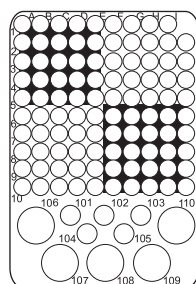

110  
100 #22  
5 #12 & 5 #20

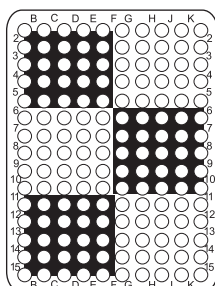

150  
150 #22

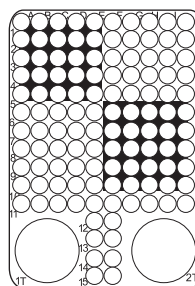

120T2  
118 #22  
2 #8 TWINAX/COAX  
(#8 Grounded to Shell)

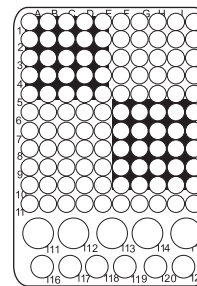

121  
110 #22  
5 #16  
6 #20

\*\* Pending ARINC release.

REAR SURFACE WHITE ON BLUE TO INDICATE REAR RELEASE. REAR REMOVAL CONTACTS FOR INSERTS CONTAINING STANDARD SIGNAL & POWER CONTACTS

(For Contact Cavity Location and Contact Cavity Identification refer to ARINC 600 or consult factory)

See Quadrax Product Bulletin for layouts accepting Size 8 Quadrax contacts.



Rack and Panel

**Table of Contents**

**BKAF - Available Receptacle Shell ONLY  
(Front Release)  
SHELL CAVITY  
A, B, D, E,**

**Rack and Panel**

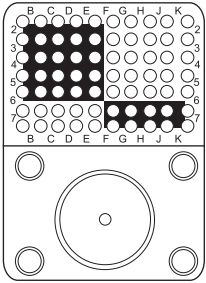

**71W1  
70 #22**

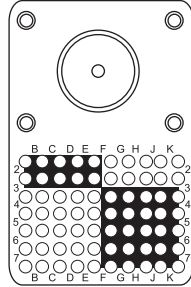

**71W1B  
70 #22**

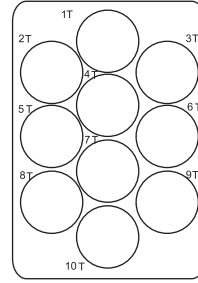

**10T10\*\*  
10 #8**

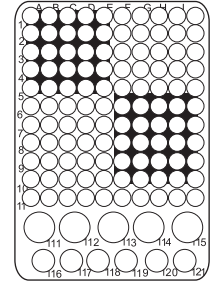

**121F  
110 #22  
6 #20  
5 #16**

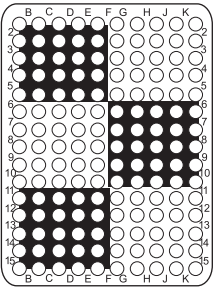

**150  
150 #22**

**ENGAGING END SURFACE WHITE ON RED TO INDICATE FRONT RELEASE FRONT REMOVAL CONTACTS FOR INSERTS CONTAINING STANDARD SIGNAL & POWER CONTACTS**

**BKAF - Available Receptacle Shell ONLY  
(Front Release)  
SHELL CAVITY C, F**

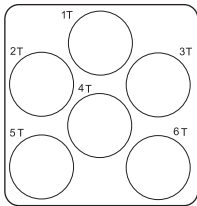

**6T6  
6 #8 TRIAX**

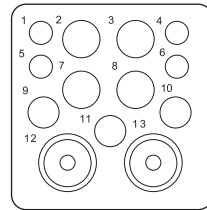

**13W2  
4 #20  
3 #16  
4 #12  
2 #5 COAX**

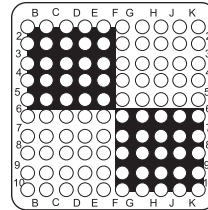

**100  
100 #22**

**NOTE #22 CONTACTS ARE SOCKETS, 20HD,16, 12 ARE PIN CONTACTS.**

**ENGAGING END SURFACE WHITE ON RED TO INDICATE FRONT RELEASE, FRONT REMOVAL CONTACTS FOR INSERTS CONTAINING STANDARD SIGNAL & POWER CONTACTS**

(For Contacts Cavity Location and Contact Cavity Identification refer to ARINC 600 or Consult Factory)

Waveguide Connections

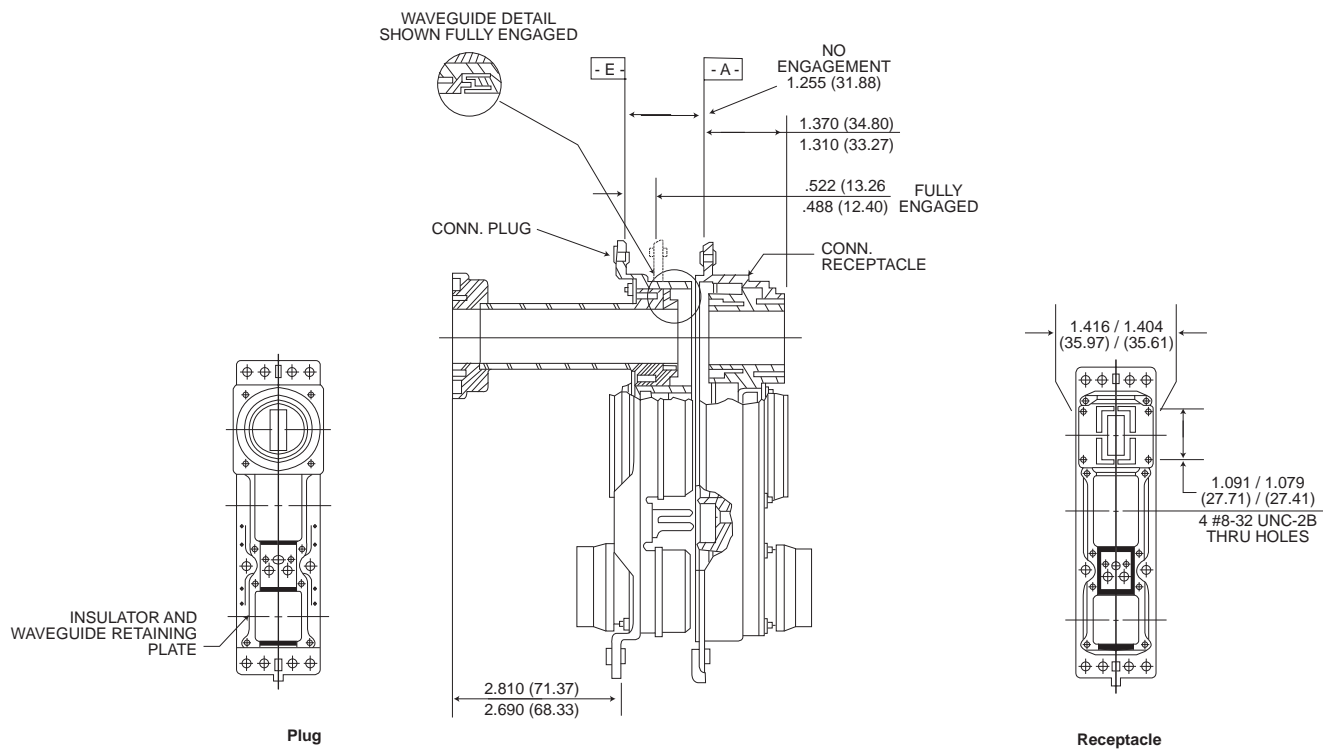

Polarization (Engaging End)

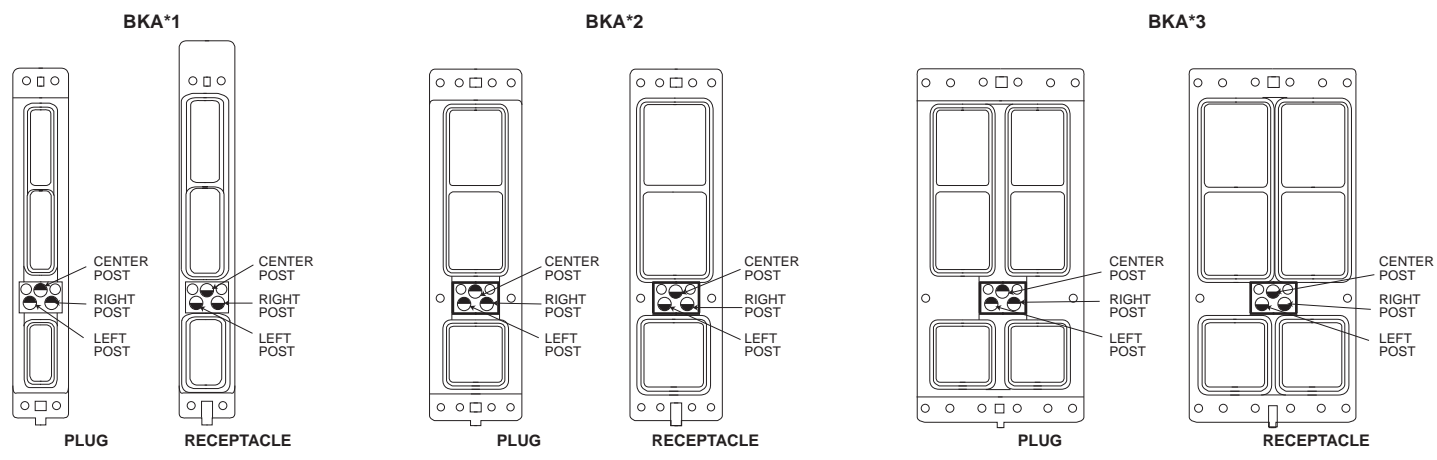

Dimensions shown in inches (mm)  
Specifications and dimensions subject to change





Contact and Termination Tooling Data

BJA\* (LIF) Crimp Contacts

Contact Size and Part Numbers			Crimp Tooling					Insertion/Extraction Tooling			Wire Size			
Size	Part Numbers		Tool P/N		Selec-tor#	Locator P/N		MIL Spec.	ITT Cannon			AWG	Insul Dia. Max	Strip Length
	Pin	Socket	MIL Spec.	ITT Cannon		Mil Spec.	ITT Cannon		Insertion	Extraction	Ins./Ext.			
2222	Used in Plug 030-2259-000	Used in Recep. 031-1287-000	M22520 /2-01	995-0001- 584	3 3 4	M22520 /2-23	995-0002- 015	M81969 /1-01	CIT-DPXMA-22-1 Metal 070256-0000	CET-DPXMA-22 Metal 070317-0000	980-0004-804 Metal Tip	26 24 22	.054 (1.4)	.130/.110 (3.3)/(2.8)
2020HD	Used in Recep 030-2273-000	Used in Plug 031-1302-000	M22520 /2-01	995-0001- 584	6 7	M22520 /2-08	995-0001- 604	M81969 /1-02	-	-	980-0004-805 Metal Tip	22 20	.071 (1.8)	.167/.147 (4.2)/(3.7)
1616	Used in Recep 030-2280-000	Used in Plug 031-1303-000	M22520 /1-01	995-0001- 585	4 5 6	M22520 /1-02	995-0001- 736	M81969 /1-03	-	CET 16-9 Plastic 323-7001-000	980-0004-806 Metal Tip	20 18 16	.103 (2.6)	.207/.230 (6.9)/(5.8)
1212	Used in Recep 030-2286-000	Used in Plug 031-1308-000	M22520 /1-01	995-0001- 585	7 8	M22520 /1-11	995-0002- 027	M81969 /14-04	-	CET 12-4 Plastic 323-7002-000	CIET-12 Plastic 323-7003-000	14 12	.135 (3.4)	.270/.230 (6.9)/(5.8)

BJA\* Thermocouple Contacts

Contact Size and Part Numbers			Crimp Tooling					Insertion/Extraction Tooling			Wire Size			
Size	Part Number		Tool P/N		Selec-tor#	Locator P/N		MIL Spec.	ITT Cannon			AWG	Insul Dia. Max	Strip Length
	Pin	Socket	MIL Spec.	ITT Cannon		Mil Spec.	ITT Cannon		Insertion	Extraction	Ins./Ext.			
2222 Alumel	Used in Plug 030-1975-009	Used in Recep. 031-1113-009	M22520 /2-01	995-0001 584	3 3 4	M22520 /2-23	995-0002- 015	M81969 /1-01	CIT-DPXMA-22-1 Metal 070256-0000	CET-DPXMA-22 Metal 070317-0000	980-0004-804 Metal Tip	26 24 22	.054 (1.4)	.130/.110 (3.3)/(2.8)
2222 Chromel	Used in Plug 030-1975-010	Used in Recep. 031-1113-010												

BKAF-ARINC 600 Size 22 Wrap Post Socket Contacts With .025(6.35) Square Wire-Wrappable Tails-Receptacle Only.

The new low insertion force, front-insertable, front-removable #22 socket contacts with .025(6.35) square wire wrappable tails are now available for use in the BKAF non-environmental receptacle version only.

These contacts can be sold separately or they can be supplied with a connector (see How to Order). Use part numbers shown in the table on the right when ordering separately.

Contact Mod.	Part Number	Number of Wraps	Min. Post Extension	Extraction Tool
WA	031-1351-000	1	.250 (6.35)	CET-22F 317-1798-001
WB	031-1351-001	2	.375 (9.52)	
WC	031-1351-002	3	.500 (12.70)	
WD	031-1351-003	3	.641 (16.28)	

BKAF Printed Circuit Solder Post Socket Contacts Size 22 with .025(6.35) Dia. Printed Circuit Tails-Receptacle Only.

The new low insertion force, front-insertable, front-removable #22 socket contacts with .025(6.35) dia., PC tails are now available for use in the BKAF non-environmental receptacle version only.

These contacts can be sold separately or they can be supplied with a connector (see How to Order). Use part numbers shown in the table on the right when ordering separately.

Contact Mod.	Part Number	Min. Post Extension	Extraction Tool
SA	031-1352-000	.150 (3.81)	CET-BKAF 22S 070393-0000
SB	031-1352-001	.250 (6.35)	
SC	031-1351-002	.375 (9.52)	
SD	031-1352-003	.500 (12.70)	

BKAD/F Solder Post, Power Pin Contacts (Captive)-Receptacle Only.

Contacts are captivated between two unbonded insulator halves.

Contact Size	Part Number	Post Dia.	Min. Post Extension*
2D HD	030-2358-000	.032 (0.81)	.150 (3.81)
16	030-2357-000	.050 (1.27)	.150 (3.81)
12	030-2356-000	.081 (2.06)	.150 (3.81)

\*Consult factory for other available lengths

BKAF Solder Post Pin Contact Front Release

Applies for BKAF inserts 143-1141-000 & 143-1142-000 only

Contact Size	Part Number	Post Dia.	Min. Post Extension	Extraction Tool
20HD	030-3287-000	.030 (0.76)	.300* (7.62)	317-1798-000
16	030-3287-001	.050 (1.27)	.300* (7.62)	317-1798-002
12	030-3287-002	.081 (2.06)	.300* (7.62)	317-1798-002

\*Applies to BKAF 13W2 and 5W2 inserts only

Front Release Pin Contacts Size 20 and 16

Applies for signal inserts using combo contact sizes with Size 22 contacts

Contact Size	Part Number	PC Tail Dia.	Min. Post Extension	Extraction Tool
20 HD	030-3296-001	.034 (0.86)/.030 (0.76)	.260 (6.60)	317-1778-000
20 HD	030-3296-002	.034 (0.86)/.030 (0.76)	.385 (9.78)	
16	030-3297-001	.052 (1.32)/.048 (1.22)	.260 (6.60)	317-1798-002
16	030-3297-002	.052 (1.32)/.048 (1.22)	.385 (9.78)	
16	030-3297-005	.052 (1.32)/.048 (1.22)	.300 (7.62)	
20 HD	030-3296-004	.034 (0.86)/.030 (0.76)	.300 (7.62)	317-1798-000

Dimensions shown in inches (mm)  
Specifications and dimensions subject to change



Size 5 Coax Contact (Rear insertable/removable)

Crimp Center Contact-Conforming to ARINC 600

Cable Accommodation	Part Number		Crimp Tooling							Extraction Tool
			Center Contact				Outer Shell			
	Pin (Receptacle Connector)	Socket (Plug Connector)	Tool		Locator		MIL STD		ITT Cannon	
			MIL Spec	ITT Cannon	Daniels	ITT Cannon	Frame	Jaw	Complete Tool	
RG-58C/U BA-5903 (BG)	349-0014-000	349-0013-000	M22520/2-01	995-0001-584	K-345	995-0002-049	M22520/5-01	M22520/5-45B	CCT-HX3-156	CET-C8 323-7011-000
5021K1011 (Raychem)	349-0016-000	349-0015-000	M22520/2-01	995-0001-584	K-345	995-0002-049	M22520/5-01	M22520/5-45B	CCT-HX3-156	CET-C8
RG-223	349-1060-000	349-1059-000	M22250/2-01	995-0001-584	K-345	995-0002-049	M22520/5-01	M22520/5-45B	CCT-HX3-156	CET-C8 323-7011-000
RG-400	-	349-1003-000	M22250/2-01	995-0001-584	K-345	995-0002-049	M22520/10-01	M22520/10-23	-	CET-C8 323-7011-000
RD-316	-	349-1004-000	M22250/2-01	995-0001-584	K-345	995-0002-049	M22520/10-01	M22520/10-23	-	CET-C8 323-7011-000
RD-316 DS	349-1004-002 less BOOT	349-1004-000 with BOOT				995-0002-049	M22520/10-01	M22520/10-23	-	CET-C8 323-7011-000

Size 12 Shielded Contact (Rear insertable/removable)

Cable Accommodation	Part Number		Crimp Tooling							Tool	
			Center Contact				Outer Shell Tool				
	Pin (Receptacle Connector)	Socket (Plug Connector)	Tool P/N		Locator P/N		MIL Std		ITT Cannon	MIL Spec	ITT Cannon
			MIL Spec	ITT Cannon	Daniels	ITT Cannon	Frame	Jaw			
RG-196A/U	249-1767-000	249-2203-001	M22520/2-01	995-0001-584	K-182	995-0002-051	M22520/1-01	M22520/10-05A	995-0001-071	M81969/28-02	CET-12-4 Plastic 323-7002-000
5071 (HW)	249-1767-001	-	M22520/2-01	995-0001-584	K-182	995-0002-051	M22520/1-01	M22520/10-05A	995-0001-071	M81969/28-02	CET-12-4 Plastic
RG-174/U	249-1767-007	249-1768-000	M22520/2-01	995-0001-584	K-182	995-0002-051	M22520/1-01	M22520/10-05A	995-0001-071	M81969/28-02	CET-12-4 Plastic
BMS-1348 (BG)	-	249-2203-000	M22520/2-01	995-0001-584	K-644	995-0002-051	M22520/1-01	M22520/10-05A	995-0001-071	M81969/28-02	CET-12-4 Plastic
RG-316	249-1767-005	-	M22520/2-01	995-0001-584	K-182	995-0002-051	M22520/10-05A				

Size 1 Modified Coaxial CONTACTS (4W4 Layout Only) Captive No Tool Required

Plug Connector

Cable Accommodation	Part Number	Coax	Style	Replacement Termination Kits	
				Solder Type	CrimpType
RG214	349-1043-001		Straight	320-1066-000	320-1066-016
AA-5886	349-1048-000		Straight	320-1066-002	320-1066-018
RG393	349-1051-000		Straight	320-1066-003	320-1066-019
ECS 311201	349-1046-000		Straight	320-1066-001	320-1066-017
AA-5887	349-1049-000		Straight	320-1066-004	320-1066-013
AA-5888	349-1050-000		Straight	320-1066-005	320-1066-014
RG142	349-1047-000		Straight	320-1066-006	320-1066-015
Various	349-1047-001	TNC Adapter		-	-

Customer Use Drawings:

All Coax contacts (except 349-1047-001) customer use drawing #349-0000-305

Crimp termination kits: Customer use drawing #320-0000-305

Solder termination kits: Customer use drawing #320-0000-304

Receptacle Connector

Cable Accommodation	Part Number	Coax	Style	Replacement Termination Kits	
				Solder Type	CrimpType
RG316 DS	349-1051-002		Straight	320-1066-008	N/A
RG142	349-1044-000		Straight	320-1066-007	N/A
Various	349-1042-000		SMA Adapter	-	-

Customer Use Drawings:

Coax contacts 349-1051-002 and 349-1044-000 are located on customer use drawing #349-0000-304

Coax contacts 349-1042-000 is located on customer use drawing #320-1042-000



Dimensions shown in inches (mm)  
Specifications and dimensions subject to change

**Sizes 1 Coax Contacts (71W1 layout only) Captive No Tool Required**

Same standard coax contacts as used in ITT's DPX (ARINC 404) connector series.

**Receptacle Connector**

Cable Accommodation	Coax Part Number	Style	Replacement Coax Termination Kit	Replacement Coax Body Assembly
RG-9/U RG-214/U	249-1521-000		249-1521-002	021-0144-000
NSA 935354 NSA 935355	-		249-2201-000	
RG-55/U RG-58/U RG-142/U RG-400/U	249-1554-000	Straight	249-1554-002	021-0144-003
RG-58/U RG-142/U RG-225/U	249-1604-001	90°	249-1604-003	021-0144-006
RG-402/U UT-141	249-1604-002			
RG-402/U UT-141	249-5027-008	Straight	249-5027-016	021-0144-001
SMA Jack Termination	249-5027-017	Straight	-	-

**Plug Connector**

Cable Accommodation	Coax Part Number	Style	Replacement Coax Termination Kit	Replacement Coax Body Assembly
RG-9/U	249-1522-000	Straight	249-1522-010	021-0144-004
NSA 935354 NSA 935355	-		249-2202-000	
RG-58/U RG-142/U	249-1882-000		249-1882-001	
RG-402/U	249-1885-002	Straight	320-0051-000	021-0144-011
RG-214/U	249-5123-000	Straight	249-5027-013	021-0144-008
RG-115/U	249-5123-001		249-5027-015	

**Sizes 1 Coax Contacts (To be used with connectors containing 71W1A, 71W1B and 2W2 insert modifier-"M")  
Captive No Tool Required**

Designed to be interchangeable with contacts made by other manufacturers.

**Receptacle Connector**

Cable Accommodation	Part Number	Style
RG-142B/U	349-0021-000	Right Angle
RG-402/U UT-141	349-0022-000	Right Angle
SMA Jack Termination	349-0023-000	Straight
RG-214/U RG-393/U BA-6903 (BG)	349-0002-000	Straight
5012H3012 (Raychem)	349-0004-000	Straight
RG-142B/U	349-0006-000	Straight
RG-402/U UT-141	349-0008-000	Straight

**Plug Connector**

Cable Accommodation	Standard Size 1 Part Number	Modular Size 1 Part Number	Termination Kit for Modular Size 1 Coax	Style
RG-214/U	349-0017-000	349-1053-003	320-1066-000	
RG-393/U	349-0017-000	-	-	Straight
BA-6903	349-0017-000	349-1053-007	320-1066-003	
5012H3012 (Raychem)	349-0018-000	-	-	Straight
RG-142B/U	349-0005-000	349-1053-006	320-1066-006	Straight
RG-402/U UT-141	349-0007-000	-	-	Straight
AA-5888	-	349-1053-008	320-1066-005	Straight
ECS-310801	-	349-1053-005	-	Straight
AA-5886	-	349-1053-004	320-1066-002	Straight
BSX-7004-502	-	349-1053-003	-	Straight
ECS-311201	-	349-1053-002	320-1066-001	Straight
AA-5887	-	349-1053-001	320-1066-004	Straight
Adam Russell PC-38	-	349-1053-000	-	Straight
TNC	349-1112-000			

Dimensions shown in inches (mm)  
Specifications and dimensions subject to change

## Size 8 Coaxial Contacts

### Plug Connector

Contact Type Socket Part Number	*Engagement		**Termination				RF Cable Number
	Short	Long	Crimp RR-RR	Crimp FR-RR	Solder .250 (6.35)	FR-FR .375 (9.52)	
△ 349-1087-003	-	-	X				Adams-Russell Co. Inc. FC11Z
△ 349-1087-004	-	-	X				Adams-Russell Co. Inc. FC14Z

### Receptacle Connector

Contact Type Socket Part Number	*Engagement		**Termination				RF Cable Number
	Short	Long	Crimp RR-RR	Crimp FR-RR	FR-FR .250 (6.35)	Solder .375 (9.52)	
△ 349-1084-000	-	X			X		
△ 349-1084-001	X	-			X		
△ 349-1084-002	-	X			X	X	
△ 349-1084-003	X	-			X	X	
△ 349-1086-000	-	X		X			Adams-Russell Co. Inc. FC11Z
△ 349-1086-001	-	X		X			Adams-Russell Co. Inc. FC14Z

## Size 8 Twinax Contacts

### Plug Connector

Contact Type Socket Part Number	*Engagement		**Termination				RF Cable Number
	Short	Long	Crimp RR-RR	Crimp FR-RR	Solder .250 (6.35)	FR-FR .375 (9.52)	
△ 349-1006-000	-	-	X				M17/176-00002
△ 349-1081-001	-	-	X				Tensolite Co. 24463/9 B017X-2 (LD)

### Receptacle Connector

Contact Type Socket Part Number	*Engagement		**Termination				RF Cable Number
	Short	Long	Crimp RR-RR	Crimp FR-RR	Solder FR-FR .250 (6.35) Ext.	FR-FR .375 (9.52) Ext.	
△ 349-1007-000	-	-	X				M17/176-00002
△ 349-1080-000	X	-			X		
△ 349-1080-001	-	X			X		
△ 349-1080-002	X	-				X	
△ 349-1080-003	-	X				X	
△ 349-1082-000	X	-		X			Tensolite Co. 24463/9 B017X-2 (LD)
△ 349-1082-001	-	X		X			Tensolite Co. 24463/9 B017X-2 (LD)
△ 349-1088-001	-	X	X				Tensolite Co. 24463/9 B017X-2 (LD)

## Size 8 Ground Contacts

### Plug Connector

Contact Type Socket Part Number	*Engagement		**Termination				Wire Size
	Short	Long	Crimp RR-RR	Crimp FR-RR	Solder .250 (6.35)	FR-FR .375 (9.52)	
△ 031-3300-000	-	-	X				8, 10 AWG

### Receptacle Connector

Contact Type Socket Part Number	*Engagement		**Termination				Wire Size
	Short	Long	Crimp RR-RR	Crimp FR-RR	Solder .250 (6.35)	FR-FR .375 (9.52)	
△ 030-3306-000	-	X			X		8, 10 AWG
△ 030-3306-001	-	X				X	8, 10 AWG
△ 030-3676-000	-	-		X			8, 10 AWG

\* The electrical engagement of "Long" contacts is .150 (3.81) greater than the electrical engagement of "Short" contact.

\*\*RR-RR indicates rear release, rear removal.  
FR-RR indicates front release, rear removal.  
FR-FR indicates front release, front removal.

△ Insertion Tool PN 038897-0004; Extraction Tool PN 323-7004-001

△ Insertion Tool PN 317-1796-000; Extraction Tool PN 317-1796-000

△ Insertion Tool Only 070170-0000



Dimensions shown in inches (mm)  
Specifications and dimensions subject to change

www.ittcannon.com





## Sealing Plugs-BKAE Environmental Connectors Only

P/N 225-0090-000  
Material: Teflon  
(All others thermoplastic)

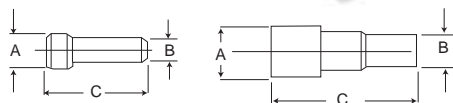

Part Number	Contact Size	Color	A	B	C
225-1013-000	22	Black	.063 (1.6)	.040 (1.0)	.469 (11.9)
225-0070-000	20	Red	.085 (2.2)	.053 (1.3)	.805/.755 (20.5/19.2)
225-0071-000	16	Blue	.115 (2.9)	.074 (1.88)	1.472/1.422 (37.4/36.1)
225-0072-000	12	Yellow	.171 (4.3)	.120 (3.0)	1.331/1.391 (36.6/35.5)
225-0090-000	#5 and #9 Coax	White	.365 (9.3)	.287 (7.3)	.835 (21.2)

## Filler Plugs-BKAD Non-Environmental Connectors Only

P/N 225-0099-000  
Material: Teflon  
(All others thermoplastic)

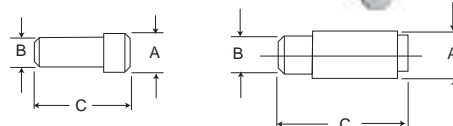

BKAF Size 22 P/N 225-1058-000

Part Number	Contact Size	Color	A	B	C
225-0094-000	22	Black	.069 (1.7)	.051 (1.3)	.420 (10.7)
225-0095-000	20	Red	.083 (2.1)	.069 (1.7)	.350 (8.9)
225-0096-000	16	Blue	.131 (3.3)	.108 (2.7)	.320 (8.1)
225-0097-000	12	Yellow	.187 (4.7)	.156 (4.0)	.320 (8.1)
225-0098-000	#5 Coax (Pin)	White	.275 (7.0)	.251 (6.4)	.450 (11.4)
225-0099-000	#5 and #9 Coax (Socket)	White	.275 (7.0)	.251 (6.4)	1.061 (26.9)

## Cavity Reducer



Pin  
P/N 021-8756-000



Socket  
P/N 021-8757-000

### #5 Coax to #12 Contact

Cavity reducers are available when additional circuits are required for size 12 power contacts. These reducers, having the internal configuration of size 12 power contact, are inserted into the size 5 coaxial insulator cavity to create size 12 power contact cavity.

(Non removable)

## Dust Caps

Conductive dust caps protect against static electricity (black).



Part Number	Description	Part Number	Description
025-1121-001	BKAD 1-A & B-Plug	025-1155-001	BKAD 1-A&B-Receptacle
025-1122-001	BKAD 1-C-Plug	025-1156-001	BKAD 1-C-Receptacle
025-1123-001	BKAD 2&3-A & B-Plug	025-1157-001	BKAD 2&3-A & B-Receptacle
025-1124-001	BKAD 2&3-C-Plug	025-1158-001	BKAD 2&3-C-Receptacle

Note: For plug connectors with EMI grounding springs (Mod22) use the following dust cap part numbers.

BKA Size 1 plug 025-1218-001  
BKA Size 2 plug 025-1218-000

## Size 8 Filler/Sealing Plugs

Size 8	BKAE/BGG Sealing Plugs	225-1059-000 RR-RR (pin & socket)
Size 8	Pin Filler Plug FR-FR	225-1065-000/-001 short (flush with insulator)
Size 8	Pin Filler Plug RR-RR	225-1066-000
Size 8	Set Filler Plug RR-RR	225-1069-000
Size 8	Pin & Set Filler FR-RR	225-1072-000 (plastic)/-001 nickel/metal

Dimensions shown in inches (mm)  
Specifications and dimensions subject to change

www.ittcannon.com

Replaceable Inserts

Layout	Class	Part Number	
		Pin Assembly	Socket Assembly
2W2**	BKAD	144-2944-000	144-2945-000
	BKAE	144-2944-000	144-2945-000
A	BKAE	143-1156-001	143-1157-001
4W4**	BKAD	177-1000-002	177-1001-004
	BKAE	177-1000-002	177-1001-004
5W2	BKAD	143-1912-000	143-1913-000
	BKAE	143-1912-001	143-1913-001
	BKAF	143-1141-000	N/A
6	BKAE	143-1154-001	143-1155-001
6T6	BKAD	228-1026-002	228-1012-003
	BKAE	228-1026-001	228-1012-001
	BKAF	N/A	228-1015-001
10T10	BKAD	228-1027-002	N/A
	BKAE	228-1027-001	228-1014-002
13W2	BKAD	143-1908-000	143-1909-000
	BKAE	143-1908-001	143-1909-001
	BKAF	143-1142-000	N/A
30T2	BKAD	143-1173-000	143-1174-000
	BKAE	143-1173-001	143-1174-001
34	BKAD	143-1159-001	N/A
	BKAE	143-1097-005	143-1098-005
40	BKAE	143-1171-001	143-1172-001
59*	BKAE	143-1167-001	143-1170-001
60-#20**	BKAE	143-3714-003	143-3715-003
60-#22**	BKAD	143-1910-000	143-1911-000
	BKAE	143-1910-001	143-1911-001
	BKAF	N/A	143-2065-000
71W1	BKAD	143-1958-000	143-1960-000
	BKAE	143-1958-002	143-1960-002
	BKAF	N/A	143-2090-000
71W1A*	BKAD	143-2085-001	143-2086-001
	BKAE	143-2085-000	143-2086-000
	BKAF	N/A	143-2066-000
71W1B	BKAD	143-1113-000	143-1111-000
	BKAE	143-114-000	143-1112-000
	BKAF	N/A	143-1118-000
85	BKAD	143-3877-000	143-3878-000
	BKAE	143-3879-000	143-3880-000
	BKAF	N/A	143-1178-000
100	BKAD	143-2015-000	143-2016-000
	BKAE	143-2015-001	143-2016-001
	BKAF	N/A	143-2067-000
110	BKAE	143-1182-000	143-1183-000
120T2	BKAD	N/A	143-1166-002
	BKAE	143-1165-003	143-1166-001
	BKAF	N/A	143-1177-000
121	BKAD	143-1150-002	143-1158-002
	BKAE	143-1150-001	143-1158-001
150	BKAD	143-1906-000	143-1907-000
	BKAE	143-1906-001	143-1907-001
	BKAF	N/A	143-2068-000

Consult factory for Insert Part Numbers not listed.

\*Modified 71W1 insert to be used with connectors containing 71W1 insert modifier "M"

\*\*Pin Inserts' accept receptacle coax contacts. \*Socket Inserts" accept plug coax contacts.



Rack and Panel



Cross Reference-Part Number/Customer-Use Drawing

COMPONENT PART NUMBER	CUSTOMER USE DRAWING NUMBER	COMPONENT PART NUMBER	CUSTOMER USE DRAWING NUMBER	COMPONENT PART NUMBER	CUSTOMER USE DRAWING NUMBER
<b>Contacts</b>		143-1908-000		<b>Replacement Coax Termination Kit</b>	
030-1975-009	030-1975-009	143-1908-001	143-0000-081	249-1521-002	249-1521-002
030-1975-010	030-1975-010	143-1909-000		249-1522-009	249-1522-010
030-2259-000	030-2259-000	143-1909-001		249-1522-010	249-1522-010
030-2273-000	030-2273-000	143-1910-000		249-1554-002	249-1554-002
030-2280-000	030-2280-000	143-1910-001	143-0000-077	249-1604-003	249-1604-003
030-2286-000	030-2286-000	143-1911-000		249-1604-004	249-1604-004
030-2356-000	030-2356-000	143-1911-001		249-2201-000	249-1521-002
030-2357-000	030-2357-000	143-1912-000		249-2202-000	249-1522-010
030-2358-000	030-2358-000	143-1912-001	143-0000-080	249-5027-013	249-5027-013
031-1113-009	031-1113-009	143-1913-000		249-5027-015	249-5027-007
031-1113-010	031-1113-010	143-1913-001		249-5027-016	249-5027-016
031-1287-000	031-1287-000	143-1958-000		320-0051-000	1250Y
031-1302-000	031-1302-000	143-1958-002	143-0000-079	320-1066-000	
031-1303-000	031-1303-000	143-1960-000		320-1066-001	
031-1308-000	031-1308-000	143-1960-002		320-1066-002	
031-1351-000		143-2015-000		320-1066-003	320-000-305
031-1351-001	031-0000-343	143-2015-001	143-0000-078	320-1066-004	
031-1351-002		143-2016-000		320-1066-005	
031-1351-003		143-2016-001		320-1066-006	
031-1352-000		143-2065-000		<b>Dust Caps</b>	
031-1252-000	031-0000-344	143-2066-000	1247Y	025-1121-001	
031-1252-002		143-2067-000		025-1122-001	025-0000-054
031-1352-003		143-2068-000		025-1123-001	(Conductive Only)
		143-2085-000		025-1124-001	
		143-2085-001	143-0000-079	025-1155-001	
		143-2086-000		025-1156-001	025-0000-055
		143-2086-001		025-1157-001	(Conductive Only)
				025-1158-001	
<b>Replacement Coax Body Assembly</b>		<b>Size #1 Coax Contacts</b>		<b>Filler Plugs</b>	
021-0144-000	021-0144-000	249-1521-000	249-1521-000	225-0094-000	
021-0144-001	021-0144-001	249-1522-000	249-1522-000	225-0095-000	
021-0144-002	021-0144-002	249-1522-002	249-1522-002	225-0096-000	225-0000-014
021-0144-003	021-0144-003	249-1554-000	249-1554-000	225-0097-000	
021-0144-004	021-0144-004	249-1604-000	249-1604-000	225-0098-000	
021-0144-006	021-0144-006	249-1604-001	249-1604-001	225-0099-000	
021-0144-008	021-0144-008	249-1604-002	249-1604-002	225-1058-000	
021-0144-011	021-0144-011	249-1882-000	249-1882-000	<b>Sealing Plugs</b>	
		249-1882-002	1250Y	225-0072-000	225-0000-006
		249-1885-002		225-0090-000	225-0090-000
		249-5027-008	249-5027-008	225-1013-000	
		249-5027-017	249-5027-017	225-1014-000	225-0000-008
		249-5123-000	249-5027-000	225-1015-000	
		249-5123-001	249-5027-007	<b>Size #5 Coax Contacts</b>	
		349-1053-000		349-0013-000	349-0000-000
		349-1053-001		349-0014-000	349-0000-001
		349-1053-002		349-0015-000	349-0000-002
		349-1053-003		349-0016-000	349-0000-001
		349-1053-004	349-0000-306	349-1003-000	
		349-1053-005		349-1009-000	349-000-301
		349-1053-006		<b>Size #12 Shielded Contact</b>	
		349-1053-007		249-1767-000	249-1767-000
		349-1053-008		249-1767-001	249-1767-001
		349-1053-009		249-1768-000	249-1768-000
				249-2203-000	249-2203-000
				<b>Replaceable Inserts</b>	
				143-1906-000	
				143-1906-001	143-0000-079
				143-1907-001	
				143-1907-001	

For part numbers not listed, consult ITT for applicable customer-use drawing.

Dimensions shown in inches (mm)  
Specifications and dimensions subject to change

ARINC 600 Connector Engaging Sequence

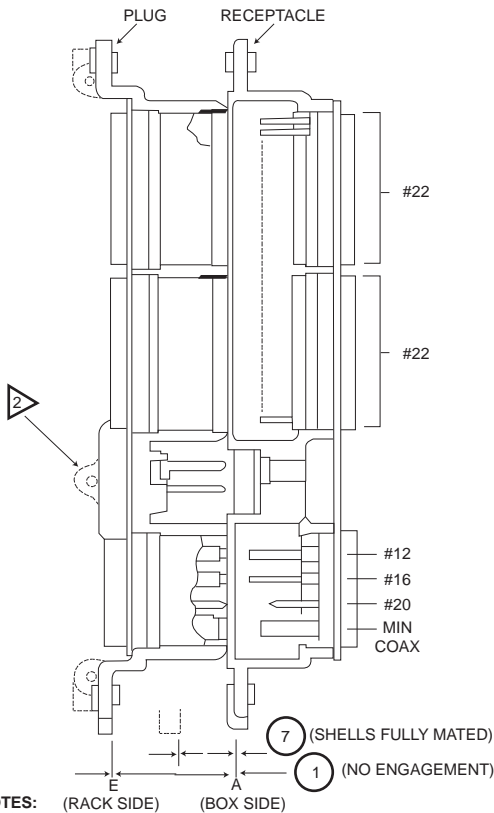

- NOTES:** (RACK SIDE) (BOX SIDE)
1. Varies; See Mil-Spec. (#5 Coax)
  2. Size 1 only.
  3. Flush head screws are not permitted for connector mounting as they would position connector incorrectly.
  4. Dimension 7 was calculated to provide clearance for
    - MCU backplate mat'l thickness of 2.5 mm (.10 in).
    - Rack backplate mat'l thickness of 2.5 mm (.10 in).
    - Connector mounting pan head screws, MCU 2.0 mm (.08 in).
    - Tolerance allowance - 3.2 mm (.13 in.) rack 2.0 mm (.08 in.)
 Total - 12.2 (.50 in) (minimum).

Mating Sequence	Flange Position With:	Flange Spacing in. (mm)
1	No Engagement	1.245 (31.62) Nom.
2	Shells Initially Engaged	1.110 (28.19) 1.073 (27.25)
3	Polarizing Pins Entering Keys	1.073 (27.25) 1.023 (25.88)
Contacts Entering Mating Insulator		
#22		.800 (22.32) .748 (18.99)
4	#20	.805 (20.44) .741 (18.82)
#16		1.012 (25.70) .949 (24.10)
#12		1.008 (23.60) .953 (24.20)
Miniature Coax		1
Contacts Electrically Engaged		
#22		.642 (16.30) .547 (13.89)
#20		.649 (16.48) .553 (14.04)
5	#16	.728 (18.49) .818 (20.77)
#12		.772 (19.60) .692 (17.57)
Miniature Coax		1
6	"0" Ring Engagement (BKAE Only)	.618 (15.70) .578 (14.68)
7	Shells Fully Mated	.522 (13.26) .488 (12.40)